

x 1

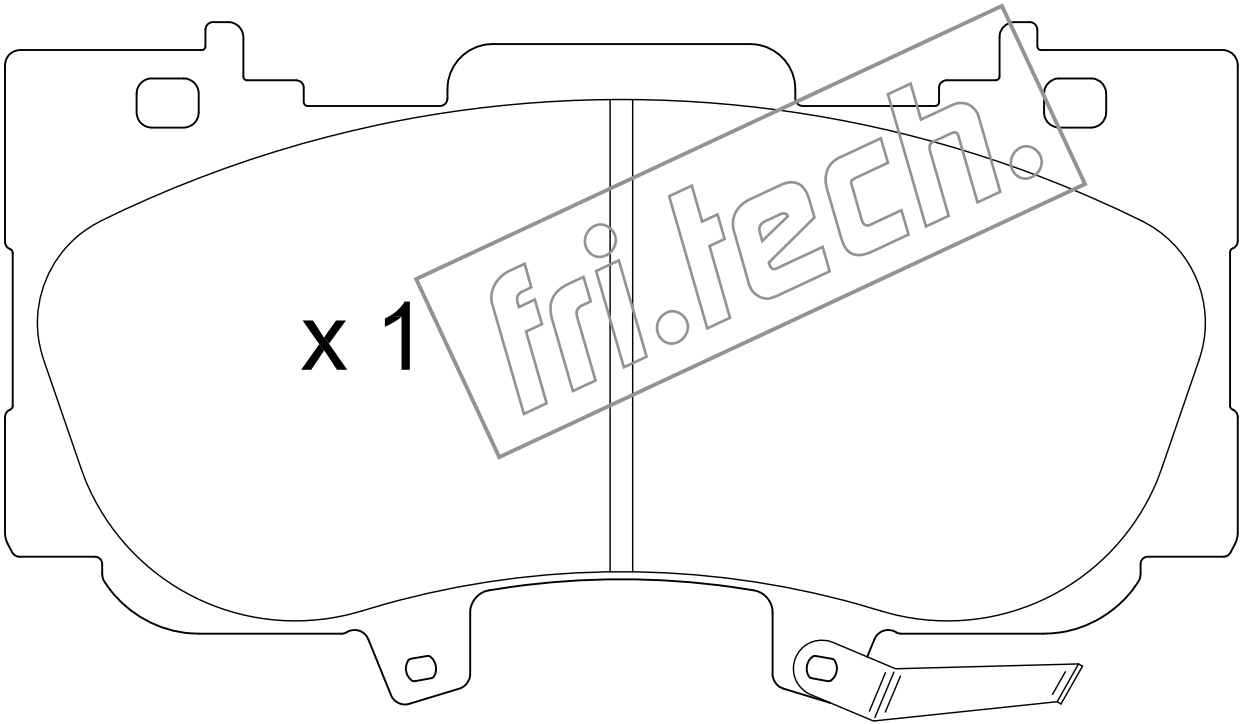

x 1

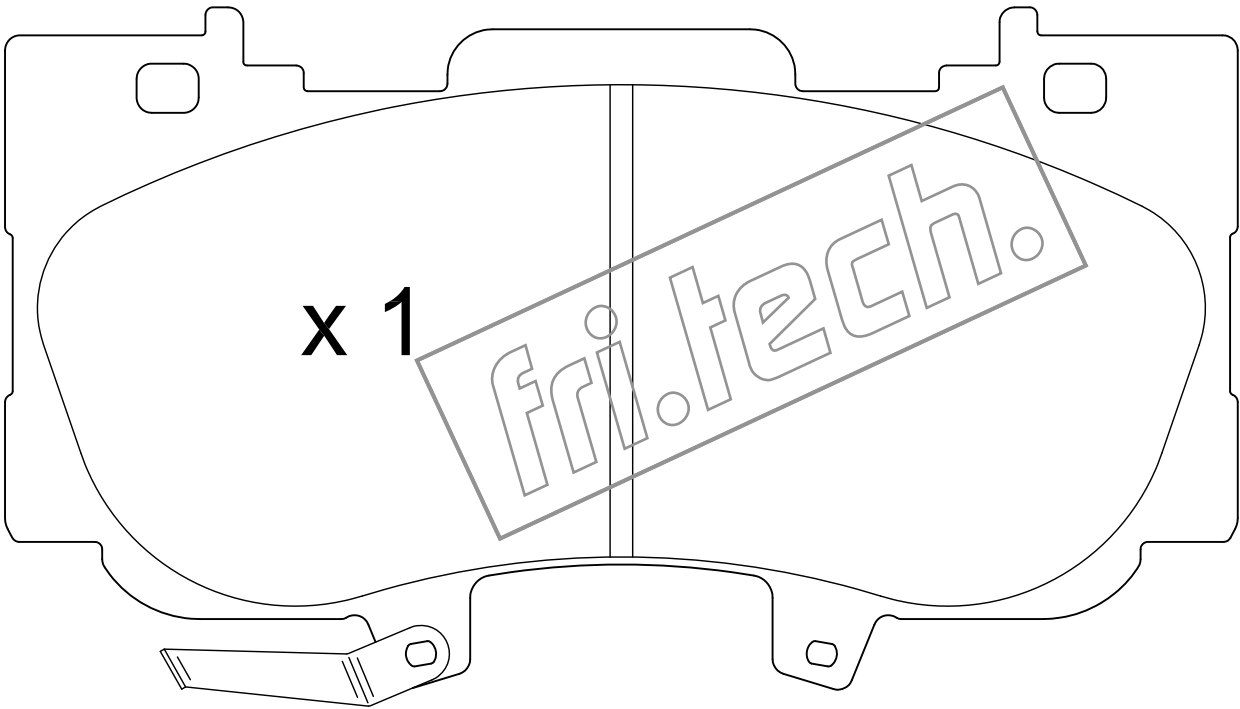

x 2

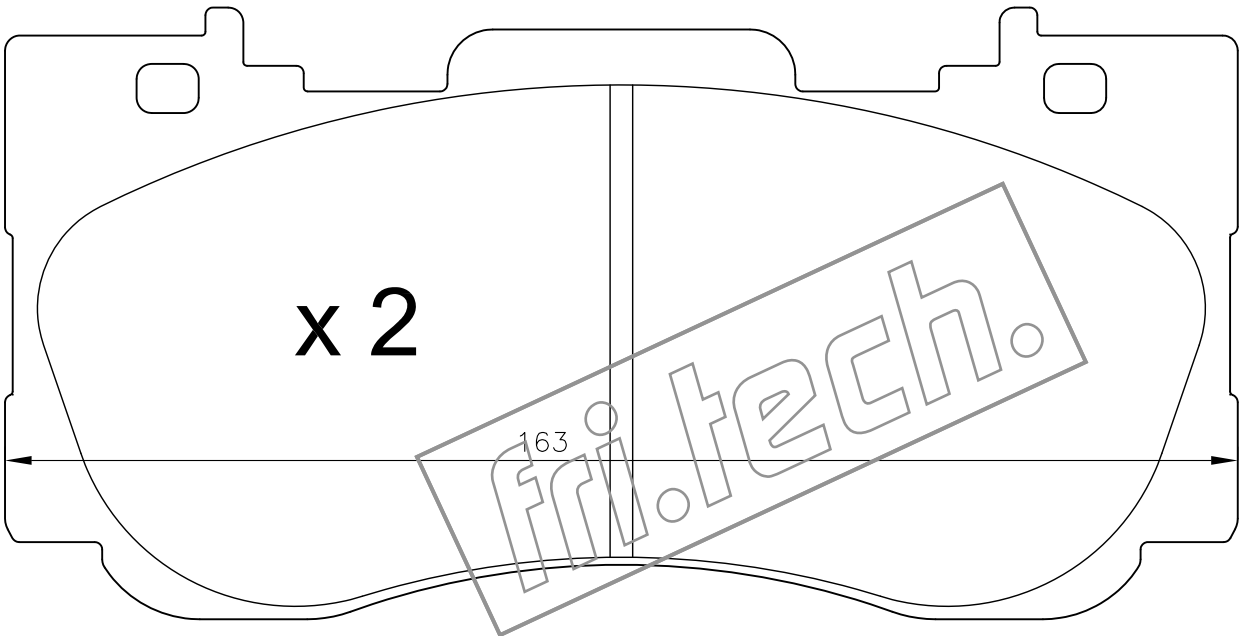

90.3



80.9

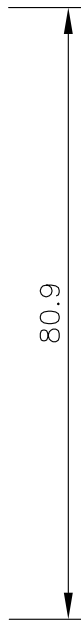

18

