

P15

workshop tool trolley
with 370 tools for 6 drawers
815.6370

THE COMPACT HEAVYWEIGHT

P15



Workshop trolley P15
with 8 compartments
873.1008



DUO Lock Brilliant locking system



Eight drawers each load capacity up to 50 kg



Stable **ball bearing**



Plastic Surface

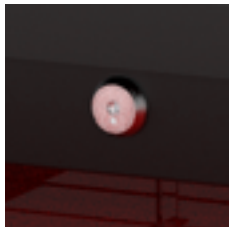

Lock lockable

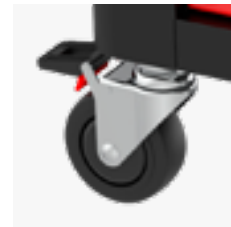

Anti-static castors with brakes



Integrated **corner protection**



Paper roll holder included



Can holder included

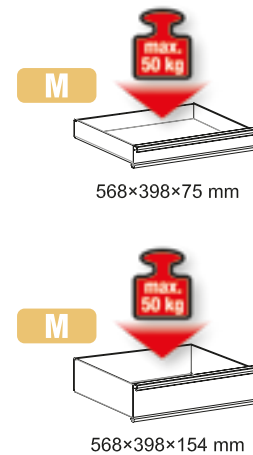
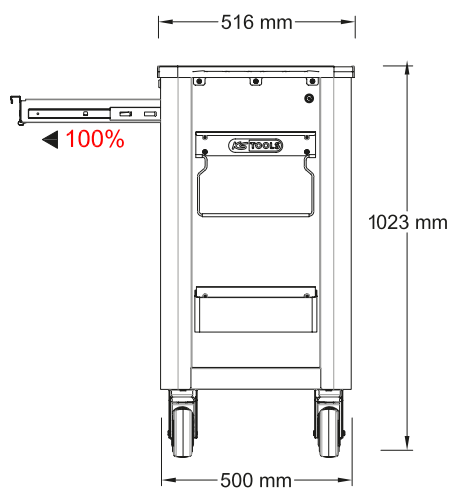
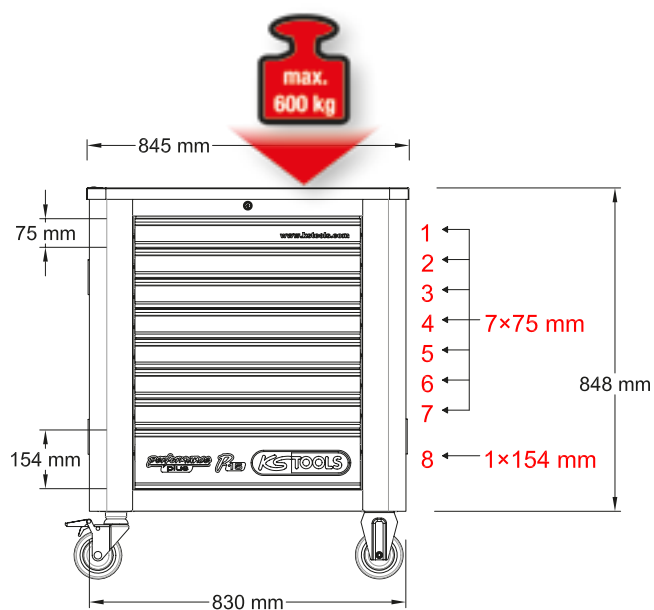

P15 workshop tool trolley set with 370 tools for 6 drawers

815.6370

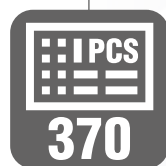

M

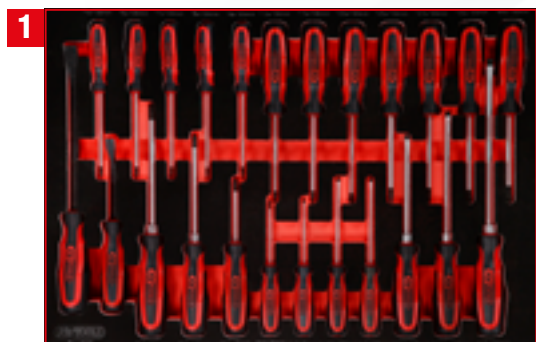

Screwdriver set in foam insert

811.0024



1/4" + 3/8" socket spanner set in foam insert

811.0148



1/2" socket spanner set in foam insert

811.1095

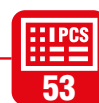
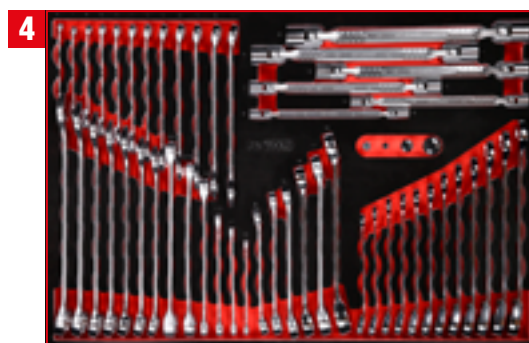

Screw spanner set in foam insert

811.0053



Pliers and file set in foam insert

811.0019



Hammer and chisel set in foam insert

811.0022

811.0024

M Screwdriver set

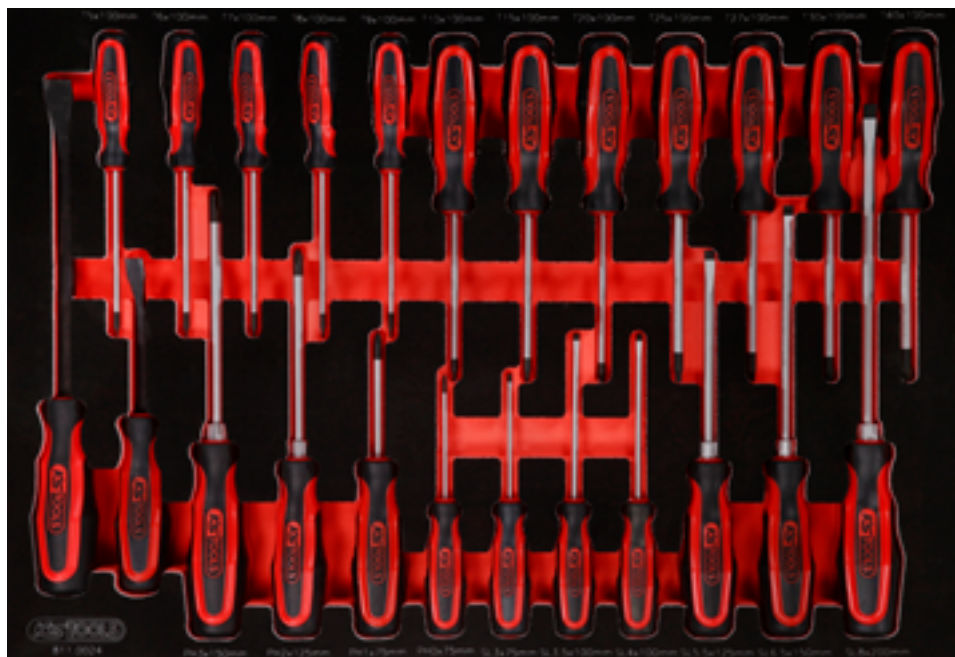

| Pos. | Code | Description | pcs |
|------|----------|---|-----|
| 1 | 911.8102 | Pry bar, 15 x 185 mm | 1 |
| 2 | 911.8101 | Pry bar, 11 x 115 mm | 1 |
| 3 | 159.1133 | ERGOTORQUEplus screwdriver, Torx, T5 | 1 |
| 4 | 159.1134 | ERGOTORQUEplus screwdriver, Torx, T6 | 1 |
| 5 | 159.1135 | ERGOTORQUEplus screwdriver, Torx, T7 | 1 |
| 6 | 159.1030 | ERGOTORQUEplus screwdriver, Torx, T8 | 1 |
| 7 | 159.1031 | ERGOTORQUEplus screwdriver, Torx, T9 | 1 |
| 8 | 159.1032 | ERGOTORQUEplus screwdriver, Torx, T10 | 1 |
| 9 | 159.1033 | ERGOTORQUEplus screwdriver, Torx, T15 | 1 |
| 10 | 159.1034 | ERGOTORQUEplus screwdriver, Torx, T20 | 1 |
| 11 | 159.1035 | ERGOTORQUEplus screwdriver, Torx, T25 | 1 |
| 12 | 159.1036 | ERGOTORQUEplus screwdriver, Torx, T27 | 1 |
| 13 | 159.1037 | ERGOTORQUEplus screwdriver, Torx, T30 | 1 |
| 14 | 159.1038 | ERGOTORQUEplus screwdriver, Torx, T40 | 1 |
| 15 | 159.1024 | ERGOTORQUEplus screwdriver, Torx, PH3, 265 mm | 1 |
| 16 | 159.1022 | ERGOTORQUEplus screwdriver, Torx, PH2, 230 mm | 1 |
| 17 | 159.1020 | ERGOTORQUEplus screwdriver, Torx, PH1, 180 mm | 1 |
| 18 | 159.1027 | ERGOTORQUEplus screwdriver, Torx, PH0, 155 mm | 1 |
| 19 | 159.1002 | ERGOTORQUEplus screwdriver for slotted screws, 3 mm, 155 mm | 1 |
| 20 | 159.1112 | ERGOTORQUEplus screwdriver for slotted screws, 3,5 mm, 180 mm | 1 |
| 21 | 159.1004 | ERGOTORQUEplus screwdriver for slotted screws, 4 mm, 180 mm | 1 |
| 22 | 159.1006 | ERGOTORQUEplus screwdriver for slotted screws, 5,5 mm, 230 mm | 1 |
| 23 | 159.1009 | ERGOTORQUEplus screwdriver for slotted screws, 6,5 mm, 255 mm | 1 |
| 24 | 159.1011 | ERGOTORQUEplus screwdriver for slotted screws, 8 mm, 315 mm | 1 |

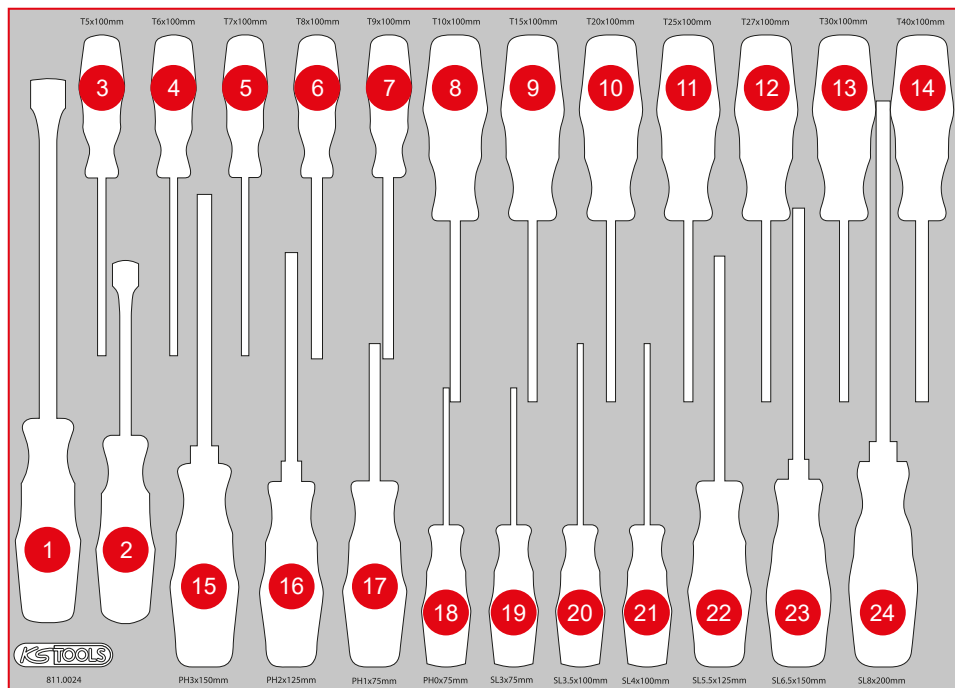

811.0148

M 1/4" + 3/8" socket spanner set



| Pos. | Code | Description | pcs | Pos. | Code | Description | pcs | Pos. | Code | Description | pcs |
|------|----------|--|-----|------|----------|--|-----|------|-----------|---|-----|
| 1 | 911.3965 | 3/8" Bit socket Torx tamperproof, TB30 | 1 | 26 | 911.3889 | 3/8" Bit socket Torx, T60 | 1 | 51 | 917.3819 | 3/8" Hexagonal socket, 19 mm | 1 |
| 2 | 911.3966 | 3/8" Bit socket Torx tamperproof, TB40 | 1 | 27 | 917.3921 | 3/8" RIBE® Bit socket, M4 | 1 | 52 | 911.1418 | 1/4" Bit socket slot, 4 mm | 1 |
| 3 | 911.3967 | 3/8" Bit socket Torx tamperproof, TB45 | 1 | 28 | 917.3922 | 3/8" RIBE® Bit socket, M5 | 1 | 53 | 911.1419 | 1/4" Bit socket slot, 5,5 mm | 1 |
| 4 | 911.3968 | 3/8" Bit socket Torx tamperproof, TB50 | 1 | 29 | 917.3923 | 3/8" RIBE® Bit socket, M6 | 1 | 54 | 917.1421 | 1/4" Bit socket slot, 6,5 mm | 1 |
| 5 | 911.3969 | 3/8" Bit socket Torx tamperproof, TB55 | 1 | 30 | 917.3924 | 3/8" RIBE® Bit socket, M7 | 1 | 55 | 917.1541 | 1/4" Bit socket spline (XZN), M4 | 1 |
| 6 | 911.3970 | 3/8" Bit socket Torx tamperproof, TB60 | 1 | 31 | 917.3925 | 3/8" RIBE® Bit socket, M8 | 1 | 56 | 917.1542 | 1/4" Bit socket spline (XZN), M5 | 1 |
| 7 | 911.3916 | 3/8" Bit socket spline (XZN), M6 | 1 | 32 | 917.3926 | 3/8" RIBE® Bit socket, M9 | 1 | 57 | 917.1543 | 1/4" Bit socket spline (XZN), M6 | 1 |
| 8 | 911.3917 | 3/8" Bit socket spline (XZN), M8 | 1 | 33 | 917.3927 | 3/8" RIBE® Bit socket, M10 | 1 | 58 | 917.1545 | 1/4" Bit socket spline (XZN), M8 | 1 |
| 9 | 917.3901 | 3/8" Bit socket spline (XZN), M9 | 1 | 34 | 917.3928 | 3/8" RIBE® Bit socket, M12 | 1 | 59 | 911.1436 | 1/4" Bit socket hexagon, 3 mm | 1 |
| 10 | 911.3920 | 3/8" Bit socket spline (XZN), M10 | 1 | 35 | 911.3892 | Adaptor, 3/8" Fx1/2" M | 1 | 60 | 911.1437 | 1/4" Bit socket hexagon, 4 mm | 1 |
| 11 | 917.3903 | 3/8" Bit socket spline (XZN), M12 | 1 | 36 | 911.3826 | 3/8" Sliding / reducing adaptor, 1/2" F x 3/8" M | 1 | 61 | 911.1438 | 1/4" Bit socket hexagon, 5 mm | 1 |
| 12 | 911.3866 | 3/8" Bit socket hexagon, 6 mm | 1 | 37 | 911.4342 | 3/8" Torx E Socket, E8 | 1 | 62 | 911.14385 | 1/4" Bit socket hexagon, 5,5 mm | 1 |
| 13 | 911.3867 | 3/8" Bit socket hexagon, 7 mm | 1 | 38 | 911.4318 | 3/8" Torx E Socket, E10 | 1 | 63 | 911.1439 | 1/4" Bit socket hexagon, 6 mm | 1 |
| 14 | 911.3868 | 3/8" Bit socket hexagon, 8 mm | 1 | 39 | 911.4319 | 3/8" Torx E Socket, E11 | 1 | 64 | 911.1440 | 1/4" Bit socket hexagon, 7 mm | 1 |
| 15 | 917.3969 | 3/8" Bit socket hexagon, 9 mm | 1 | 40 | 911.4320 | 3/8" Torx E Socket, E12 | 1 | 65 | 911.1441 | 1/4" Bit socket hexagon, 8 mm | 1 |
| 16 | 917.3857 | 3/8" Bit socket hexagon, 10 mm | 1 | 41 | 911.4321 | 3/8" Torx E Socket, E14 | 1 | 66 | 911.1401 | 1/4" Bit socket, PZ1 | 1 |
| 17 | 911.3862 | 3/8" Bit socket hexagon, 12 mm | 1 | 42 | 917.3810 | 3/8" Hexagonal socket, 10 mm | 1 | 67 | 911.1402 | 1/4" Bit socket, PZ2 | 1 |
| 18 | 911.3897 | Reducing adaptor, 3/8" Fx1/4" M | 1 | 43 | 917.3811 | 3/8" Hexagonal socket, 11 mm | 1 | 68 | 911.1403 | 1/4" Bit socket, PZ3 | 1 |
| 19 | 911.3871 | 3/8" Bit socket Torx, T25 | 1 | 44 | 917.3812 | 3/8" Hexagonal socket, 12 mm | 1 | 69 | 917.1578 | 1/4" Torx Plus bit socket 8IPR | 1 |
| 20 | 911.3872 | 3/8" Bit socket Torx, T27 | 1 | 45 | 917.3813 | 3/8" Hexagonal socket, 13 mm | 1 | 70 | 911.1701 | 1/4" Bit socket five star tamperproof, TS10 | 1 |
| 21 | 911.3873 | 3/8" Bit socket Torx, T30 | 1 | 46 | 917.3814 | 3/8" Hexagonal socket, 14 mm | 1 | 71 | 911.1702 | 1/4" Bit socket five star tamperproof, TS15 | 1 |
| 22 | 911.3874 | 3/8" Bit socket Torx, T40 | 1 | 47 | 917.3815 | 3/8" Hexagonal socket, 15 mm | 1 | 72 | 911.1703 | 1/4" Bit socket five star tamperproof, TS20 | 1 |
| 23 | 911.3885 | 3/8" Bit socket Torx, T45 | 1 | 48 | 917.3816 | 3/8" Hexagonal socket, 16 mm | 1 | 73 | 911.1704 | 1/4" Bit socket five star tamperproof, TS25 | 1 |
| 24 | 911.3884 | 3/8" Bit socket Torx, T50 | 1 | 49 | 917.3817 | 3/8" Hexagonal socket, 17 mm | 1 | 74 | 911.1705 | 1/4" Bit socket five star tamperproof, TS27 | 1 |
| 25 | 911.3888 | 3/8" Bit socket Torx, T55 | 1 | 50 | 917.3818 | 3/8" Hexagonal socket, 18 mm | 1 | 75 | 911.1706 | 1/4" Bit socket five star tamperproof, TS30 | 1 |

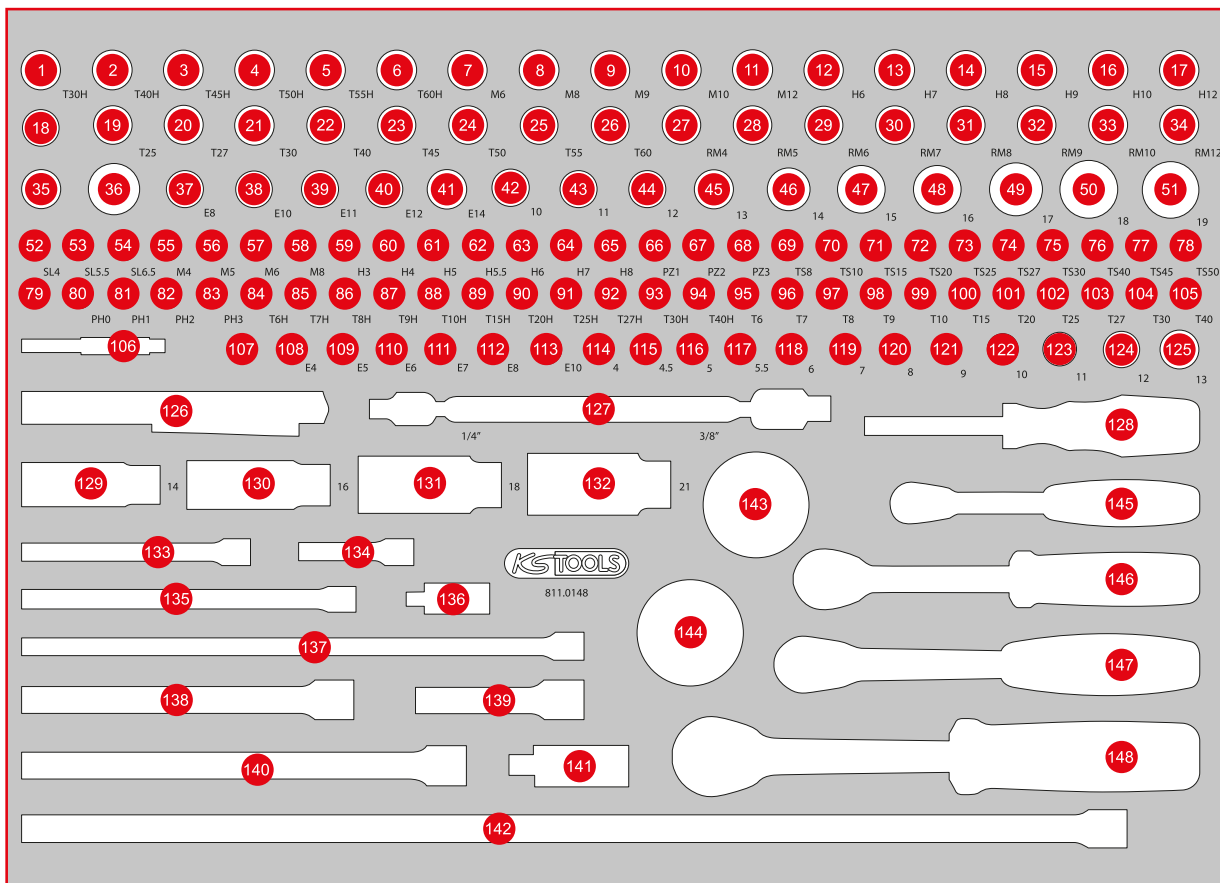

| Pos. | Code | Description | pcs | Pos. | Code | Description | pcs | Pos. | Code | Description | pcs |
|------|----------|---|-----|------|-----------|-------------------------------|-----|------|----------|--|-----|
| 76 | 911.1707 | 1/4" Bit socket five star tamperproof, TS40 | 1 | 101 | 911.1444 | 1/4" Bit socket Torx, T20 | 1 | 126 | 150.4370 | perfectLight torch 85 lumen | 1 |
| 77 | 911.1708 | 1/4" Bit socket five star tamperproof, TS45 | 1 | 102 | 911.1445 | 1/4" Bit socket Torx, T25 | 1 | 127 | 517.0338 | Double-joint-spanner for 1/4" and 3/8" sockets | 1 |
| 78 | 911.1709 | 1/4" Bit socket five star tamperproof, TS50 | 1 | 103 | 911.1449 | 1/4" Bit socket Torx, T27 | 1 | 128 | 911.1434 | 1/4" Square drive screwdriver, 150 mm | 1 |
| 79 | 911.1494 | Adaptor, 1/4" Mx3/8" F | 1 | 104 | 911.1446 | 1/4" Bit socket Torx, T30 | 1 | 129 | 911.3990 | 3/8" Special spark plug socket, thin-walled, 14 mm | 1 |
| 80 | 911.1482 | 1/4" Bit socket, PH0 | 1 | 105 | 911.1447 | 1/4" Bit socket Torx, T40 | 1 | 130 | 911.3804 | 3/8" Spark plug socket, 16 mm | 1 |
| 81 | 911.1415 | 1/4" Bit socket, PH1 | 1 | 106 | 514.1106 | Socket adaptor, 1/4"x1/4" | 1 | 131 | 911.3823 | 3/8" Spark plug socket, 18 mm | 1 |
| 82 | 911.1416 | 1/4" Bit socket, PH2 | 1 | 107 | 911.0101 | 1/4" socket with magnet | 1 | 132 | 911.3805 | 3/8" Spark plug socket, 21 mm | 1 |
| 83 | 911.1417 | 1/4" Bit socket, PH3 | 1 | 108 | 911.4313 | 1/4" Torx E Socket, E4 | 1 | 133 | 911.1424 | 1/4" Extension with hexagon drive, 100 mm | 1 |
| 84 | 917.1456 | 1/4" Bit socket Torx tamperproof, TB6 | 1 | 109 | 911.4314 | 1/4" Torx E Socket, E5 | 1 | 134 | 911.1423 | 1/4" Extension with hexagon drive, 50 mm | 1 |
| 85 | 917.1457 | 1/4" Bit socket Torx tamperproof, TB7 | 1 | 110 | 911.4315 | 1/4" Torx E Socket, E6 | 1 | 135 | 911.1451 | 1/4" Extension with hexagon drive, 150 mm | 1 |
| 86 | 911.1461 | 1/4" Bit socket Torx tamperproof, TB8 | 1 | 111 | 911.4316 | 1/4" Torx E Socket, E7 | 1 | 136 | 911.1450 | 1/4" Universal joint | 1 |
| 87 | 911.1485 | 1/4" Bit socket Torx tamperproof, TB9 | 1 | 112 | 911.4317 | 1/4" Torx E Socket, E8 | 1 | 137 | 911.1543 | 1/4" Wobble extension with hexagon drive, 250 mm | 1 |
| 88 | 911.1462 | 1/4" Bit socket Torx tamperproof, TB10 | 1 | 113 | 911.4332 | 1/4" Torx E Socket, E10 | 1 | 138 | 911.3802 | 3/8" Extension with knurling, 150 mm | 1 |
| 89 | 911.1463 | 1/4" Bit socket Torx tamperproof, TB15 | 1 | 114 | 917.1404 | 1/4" Hexagonal socket, 4 mm | 1 | 139 | 911.3801 | 3/8" Extension with knurling, 75 mm | 1 |
| 90 | 911.1464 | 1/4" Bit socket Torx tamperproof, TB20 | 1 | 115 | 917.14045 | 1/4" Hexagonal socket, 4,5 mm | 1 | 140 | 911.3856 | 3/8" Extension with knurling, 200 mm | 1 |
| 91 | 911.1465 | 1/4" Bit socket Torx tamperproof, TB25 | 1 | 116 | 917.1405 | 1/4" Hexagonal socket, 5 mm | 1 | 141 | 911.3850 | 3/8" Universal joint | 1 |
| 92 | 911.1466 | 1/4" Bit socket Torx tamperproof, TB27 | 1 | 117 | 917.14055 | 1/4" Hexagonal socket, 5,5 mm | 1 | 142 | 920.1490 | 1/4" SlimPOWER Reversible ratchet, 72 teeth | 1 |
| 93 | 911.1467 | 1/4" Bit socket Torx tamperproof, TB30 | 1 | 118 | 917.1406 | 1/4" Hexagonal socket, 6 mm | 1 | 142 | 911.4884 | Extension, 3/8", 450 mm | 1 |
| 94 | 911.1468 | 1/4" Bit socket Torx tamperproof, TB40 | 1 | 119 | 917.1407 | 1/4" Hexagonal socket, 7 mm | 1 | 143 | 914.1410 | Mini hand reversible ratchet, 1/4", 72 teethh | 1 |
| 95 | 911.4407 | 1/4" Bit socket Torx, T6 | 1 | 120 | 917.1408 | 1/4" Hexagonal socket, 8 mm | 1 | 144 | 914.3810 | Mini hand reversible ratchet, 3/8", 72 teethh | 1 |
| 96 | 911.4362 | 1/4" Bit socket Torx, T7 | 1 | 121 | 917.1409 | 1/4" Hexagonal socket, 9 mm | 1 | 146 | 914.1425 | Twister-ratchet-handle, 1/4", 60 teeth | 1 |
| 97 | 911.1448 | 1/4" Bit socket Torx, T8 | 1 | 122 | 917.1410 | 1/4" Hexagonal socket, 10 mm | 1 | 147 | 920.3890 | 3/8" SlimPOWER Reversible ratchet, 72 teeth | 1 |
| 98 | 911.1478 | 1/4" Bit socket Torx, T9 | 1 | 123 | 917.1411 | 1/4" Hexagonal socket, 11 mm | 1 | 148 | 914.3825 | Twister-ratchet-handle, 3/8", 60 teeth | 1 |
| 99 | 911.1442 | 1/4" Bit socket Torx, T10 | 1 | 124 | 917.1412 | 1/4" Hexagonal socket, 12 mm | 1 | | | | |
| 100 | 911.1443 | 1/4" Bit socket Torx, T15 | 1 | 125 | 917.1413 | 1/4" Hexagonal socket, 13 mm | 1 | | | | |

M 1/2" Socket spanner set

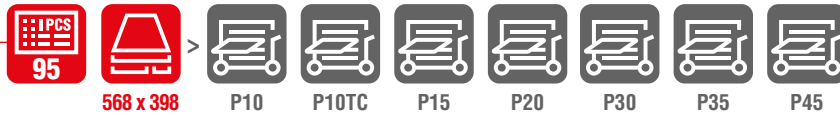

| Pos. | Code | Description | pcs | Pos. | Code | Description | pcs | Pos. | Code | Description | pcs |
|------|----------|--|-----|------|----------|--|-----|------|----------|--|-----|
| 1 | 911.1306 | 1/2" Bit socket hexagon, short, 6 mm | 1 | 17 | 911.4514 | Bit socket for RIBE screws, M8, length 55 mm | 1 | 32 | 911.1370 | 1/2" Bit socket Torx, T70 | 1 |
| 2 | 911.1307 | 1/2" Bit socket hexagon, short, 7 mm | 1 | 18 | 911.4515 | Bit socket for RIBE screws, M9, length 55 mm | 1 | 33 | 911.1340 | 1/2" Bit socket spline (XZN), M5, 55 mm | 1 |
| 3 | 911.1308 | 1/2" Bit socket hexagon, short, 8 mm | 1 | 19 | 911.4516 | Bit socket for RIBE screws, M10, length 55 mm | 1 | 34 | 911.1341 | 1/2" Bit socket spline (XZN), M6, 55 mm | 1 |
| 4 | 911.1309 | 1/2" Bit socket hexagon, short, 9 mm | 1 | 20 | 911.4551 | Bit socket for RIBE screws, M10.1, length 55 mm | 1 | 35 | 911.1342 | 1/2" Bit socket spline (XZN), M8, 55 mm | 1 |
| 5 | 911.1310 | 1/2" Bit socket hexagon, short, 10 mm | 1 | 21 | 911.4517 | Bit socket for RIBE screws, M12, length 55 mm | 1 | 36 | 911.1313 | 1/2" Bit socket spline (XZN), M9, 55 mm | 1 |
| 6 | 911.1312 | 1/2" Bit socket hexagon, short, 12 mm | 1 | 22 | 911.4518 | Bit socket for RIBE screws, M13, length 55 mm | 1 | 37 | 911.1343 | 1/2" Bit socket spline (XZN), M10, 55 mm | 1 |
| 7 | 911.1314 | 1/2" Bit socket hexagon, short, 14 mm | 1 | 23 | 911.4519 | Bit socket for RIBE screws, M14, length 55 mm | 1 | 38 | 911.1344 | 1/2" Bit socket spline (XZN), M12, 55 mm | 1 |
| 8 | 911.1317 | 1/2" Bit socket hexagon, short, 17 mm | 1 | 24 | 911.1348 | 1/2" Bit socket spline (XZN) tamperproof, M16, 55 mm | 1 | 39 | 911.1345 | 1/2" Bit socket spline (XZN), M14, 55 mm | 1 |
| 9 | 911.1373 | 1/2" Bit socket Torx tamperproof, TB27 | 1 | 25 | 911.1363 | 1/2" Bit socket Torx, T27 | 1 | 40 | 911.1346 | 1/2" Bit socket spline (XZN), M16, 55 mm | 1 |
| 10 | 911.1374 | 1/2" Bit socket Torx tamperproof, TB30 | 1 | 26 | 911.1364 | 1/2" Bit socket Torx, T30 | 1 | 41 | 911.5306 | 1/2" Bit socket spline (XZN), M17, 55 mm | 1 |
| 11 | 911.1375 | 1/2" Bit socket Torx tamperproof, TB40 | 1 | 27 | 911.1365 | 1/2" Bit socket Torx, T40 | 1 | 42 | 911.4335 | 1/2" Torx E Socket, E12 | 1 |
| 12 | 911.1376 | 1/2" Bit socket Torx tamperproof, TB45 | 1 | 28 | 911.1366 | 1/2" Bit socket Torx, T45 | 1 | 43 | 911.4336 | 1/2" Torx E Socket, E14 | 1 |
| 13 | 911.1377 | 1/2" Bit socket Torx tamperproof, TB50 | 1 | 29 | 911.1367 | 1/2" Bit socket Torx, T50 | 1 | 44 | 911.4322 | 1/2" Torx E Socket, E16 | 1 |
| 14 | 911.1378 | 1/2" Bit socket Torx tamperproof, TB55 | 1 | 30 | 911.1368 | 1/2" Bit socket Torx, T55 | 1 | 45 | 911.4323 | 1/2" Torx E Socket, E18 | 1 |
| 15 | 911.1379 | 1/2" Bit socket Torx tamperproof, TB60 | 1 | 31 | 911.1369 | 1/2" Bit socket Torx, T60 | 1 | 46 | 911.4324 | 1/2" Torx E Socket, E20 | 1 |
| 16 | 911.1380 | 1/2" Bit socket Torx tamperproof, TB70 | 1 | | | | | 47 | 911.4325 | 1/2" Torx E Socket, E22 | 1 |

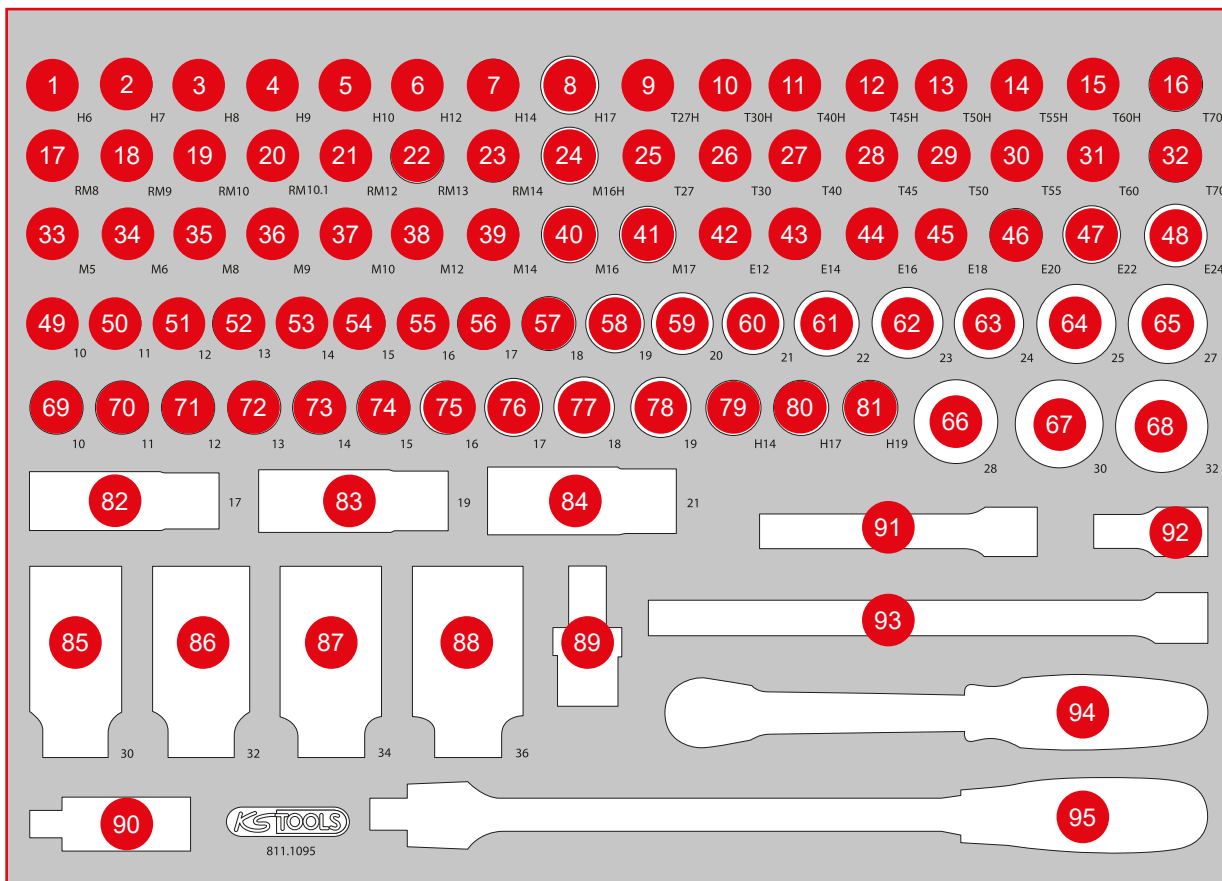

| Pos. | Code | Description | pcs | Pos. | Code | Description | pcs | Pos. | Code | Description | pcs |
|------|----------|------------------------------|-----|------|----------|---|-----|------|----------|--|-----|
| 48 | 911.4326 | 1/2" Torx E Socket, E24 | 1 | 64 | 917.1343 | 1/2" Hexagonal socket, 26 mm | 1 | 80 | 911.0909 | 1/2" Impact bit socket, hexagon, short, 17 mm | 1 |
| 49 | 917.1210 | 1/2" Hexagonal socket, 10 mm | 1 | 65 | 917.1227 | 1/2" Hexagonal socket, 27 mm | 1 | 81 | 911.0911 | 1/2" Impact bit socket, hexagon, short, 19 mm | 1 |
| 50 | 917.1211 | 1/2" Hexagonal socket, 11 mm | 1 | 66 | 917.1344 | 1/2" Hexagonal socket, 28 mm | 1 | 82 | 515.0992 | SlimPOWER 1/2"Alloy rim impact socket, 17 mm | 1 |
| 51 | 917.1212 | 1/2" Hexagonal socket, 12 mm | 1 | 67 | 917.1230 | 1/2" Hexagonal socket, 30 mm | 1 | 83 | 515.0993 | SlimPOWER 1/2"Alloy rim impact socket, 19 mm | 1 |
| 52 | 917.1213 | 1/2" Hexagonal socket, 13 mm | 1 | 68 | 917.1232 | 1/2" Hexagonal socket, 32 mm | 1 | 84 | 515.0994 | SlimPOWER 1/2"Alloy rim impact socket, 21 mm | 1 |
| 53 | 917.1214 | 1/2" Hexagonal socket, 14 mm | 1 | 69 | 515.1010 | 1/2" Hexagon impact socket short, 10 mm | 1 | 85 | 150.1705 | Special drive shaft impact socket, 1/2", 30 mm | 1 |
| 54 | 917.1215 | 1/2" Hexagonal socket, 15 mm | 1 | 70 | 515.1011 | 1/2" Hexagon impact socket short, 11 mm | 1 | 86 | 150.1706 | Special drive shaft impact socket, 1/2", 32 mm | 1 |
| 55 | 917.1216 | 1/2" Hexagonal socket, 16 mm | 1 | 71 | 515.1012 | 1/2" Hexagon impact socket short, 12 mm | 1 | 87 | 150.1704 | Special drive shaft impact socket, 1/2", 34 mm | 1 |
| 56 | 917.1217 | 1/2" Hexagonal socket, 17 mm | 1 | 72 | 515.1013 | 1/2" Hexagon impact socket short, 13 mm | 1 | 88 | 150.1707 | Special drive shaft impact socket, 1/2", 36 mm | 1 |
| 57 | 917.1218 | 1/2" Hexagonal socket, 18 mm | 1 | 73 | 515.1014 | 1/2" Hexagon impact socket short, 14 mm | 1 | 89 | 515.1133 | 1/2" Impact universal ball joint | 1 |
| 58 | 917.1219 | 1/2" Hexagonal socket, 19 mm | 1 | 74 | 515.1015 | 1/2" Hexagon impact socket short, 15 mm | 1 | 90 | 911.1250 | 1/2" Universal joint | 1 |
| 59 | 917.1220 | 1/2" Hexagonal socket, 20 mm | 1 | 75 | 515.1016 | 1/2" Hexagon impact socket short, 16 mm | 1 | 91 | 911.1202 | 1/2" Extensions, 125 mm | 1 |
| 60 | 917.1221 | 1/2" Hexagonal socket, 21 mm | 1 | 76 | 515.1017 | 1/2" Hexagon impact socket short, 17 mm | 1 | 92 | 911.1381 | Wobble extension, 1/2", 50 mm | 1 |
| 61 | 917.1222 | 1/2" Hexagonal socket, 22 mm | 1 | 77 | 515.1018 | 1/2" Hexagon impact socket short, 18 mm | 1 | 93 | 911.1203 | 1/2" Extensions, 250 mm | 1 |
| 62 | 917.1223 | 1/2" Hexagonal socket, 23 mm | 1 | 78 | 515.1019 | 1/2" Hexagon impact socket short, 19 mm | 1 | 94 | 920.1290 | 1/2" SlimPOWER Reversible ratchet, 72 teeth | 1 |
| 63 | 917.1224 | 1/2" Hexagonal socket, 24 mm | 1 | 79 | 911.0908 | 1/2" Impact bit socket, hexagon, short, 14 mm | 1 | 95 | 917.1455 | 1/2" Flexi head drive handle | 1 |

811.0053

M Screw spanner set



568 x 398



P10



P10TC



P15



P20



P30



P35



P45



| Pos. | Code | Description | pcs | Pos. | Code | Description | pcs | Pos. | Code | Description | pcs |
|------|----------|-------------------------------------|-----|------|----------|--|-----|------|----------|---|-----|
| 1 | 517.0606 | Combination spanners, offset, 6 mm | 1 | 12 | 517.0617 | Combination spanners, offset, 17 mm | 1 | 22 | 911.0373 | Double ring spanner for Torx E profile, E10 x E12 | 1 |
| 2 | 517.0607 | Combination spanners, offset, 7 mm | 1 | 13 | 517.0618 | Combination spanners, offset, 18 mm | 1 | 23 | 911.0374 | Double ring spanner for Torx E profile, E14 x E18 | 1 |
| 3 | 517.0608 | Combination spanners, offset, 8 mm | 1 | 14 | 517.0619 | Combination spanners, offset, 19 mm | 1 | 24 | 911.0375 | Double ring spanner for Torx E profile, E16 x E22 | 1 |
| 4 | 517.0609 | Combination spanners, offset, 9 mm | 1 | 15 | 517.0620 | Combination spanners, offset, 20 mm | 1 | 25 | 911.0376 | Double ring spanner for Torx E profile, E20 x E24 | 1 |
| 5 | 517.0610 | Combination spanners, offset, 10 mm | 1 | 16 | 517.0621 | Combination spanners, offset, 21 mm | 1 | 26 | 517.0252 | Open double ring spanner, offset, 8 x 10 mm | 1 |
| 6 | 517.0611 | Combination spanners, offset, 11 mm | 1 | 17 | 517.0622 | Combination spanners, offset, 22 mm | 1 | 27 | 517.9244 | Open double ring spanner, offset, 11 x 13 mm | 1 |
| 7 | 517.0612 | Combination spanners, offset, 12 mm | 1 | 18 | 517.0623 | Combination spanners, offset, 23 mm | 1 | 28 | 517.0258 | Open double ring spanner, offset, 12 x 14 mm | 1 |
| 8 | 517.0613 | Combination spanners, offset, 13 mm | 1 | 19 | 517.0624 | Combination spanners, offset, 24 mm | 1 | 29 | 517.0263 | Open double ring spanner, offset, 16 x 18 mm | 1 |
| 9 | 517.0614 | Combination spanners, offset, 14 mm | 1 | 20 | 911.0371 | Double ring spanner for Torx E profile, E6 x E8 | 1 | 30 | 517.0264 | Open double ring spanner, offset, 17 x 19 mm | 1 |
| 10 | 517.0615 | Combination spanners, offset, 15 mm | 1 | 21 | 911.0372 | Double ring spanner for Torx E profile, E7 x E11 | 1 | | | | |
| 11 | 517.0616 | Combination spanners, offset, 16 mm | 1 | | | | | | | | |

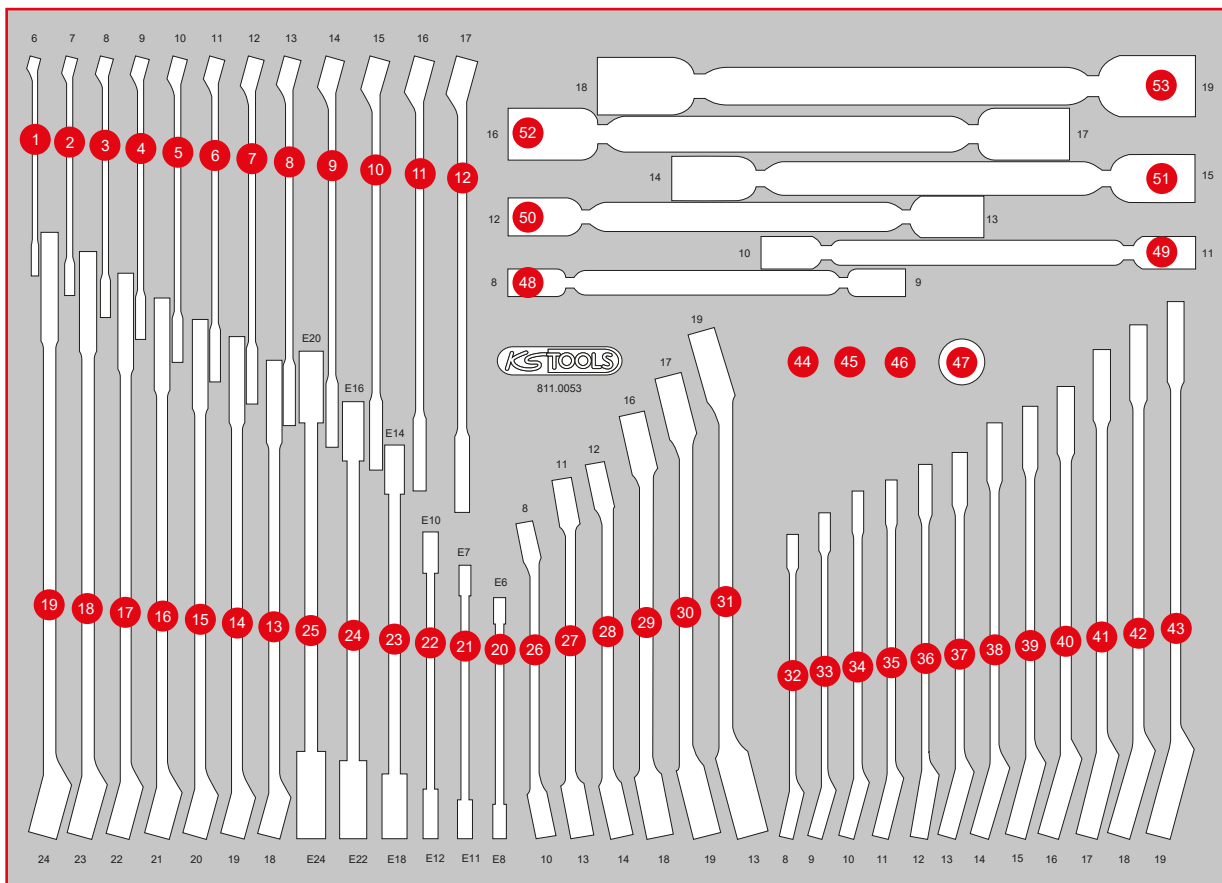

| Pos. | Code | Description | pcs | Pos. | Code | Description | pcs | Pos. | Code | Description | pcs |
|------|----------|--|-----|------|----------|--|-----|------|----------|---|-----|
| 31 | 517.0266 | Open double ring spanner, offset, 19 x 22 mm | 1 | 39 | 503.4615 | GEARplus reversing combination ratcheting spanner, 15 mm | 1 | 47 | 503.4298 | GEARplus socket adaptor, 1/2" x 19 mm | 1 |
| 32 | 503.4608 | GEARplus reversing combination ratcheting spanner, 8 mm | 1 | 40 | 503.4616 | GEARplus reversing combination ratcheting spanner, 16 mm | 1 | 48 | 517.0301 | Double revolving head spanner, 8 x 9 mm | 1 |
| 33 | 503.4609 | GEARplus reversing combination ratcheting spanner, 9 mm | 1 | 41 | 503.4617 | GEARplus reversing combination ratcheting spanner, 17 mm | 1 | 49 | 517.0302 | Double revolving head spanner, 10 x 11 mm | 1 |
| 34 | 503.4610 | GEARplus reversing combination ratcheting spanner, 10 mm | 1 | 42 | 503.4618 | GEARplus reversing combination ratcheting spanner, 18 mm | 1 | 50 | 517.0303 | Double revolving head spanner, 12 x 13 mm | 1 |
| 35 | 503.4611 | GEARplus reversing combination ratcheting spanner, 11 mm | 1 | 43 | 503.4619 | GEARplus reversing combination ratcheting spanner, 19 mm | 1 | 51 | 517.0304 | Double revolving head spanner, 14 x 15 mm | 1 |
| 36 | 503.4612 | GEARplus reversing combination ratcheting spanner, 12 mm | 1 | 44 | 503.4290 | GEARplus bit adaptor, 1/4" x 10 mm | 1 | 52 | 517.0305 | Double revolving head spanner, 16 x 17 mm | 1 |
| 37 | 503.4613 | GEARplus reversing combination ratcheting spanner, 13 mm | 1 | 45 | 503.4296 | GEARplus socket adaptor, 1/4" x 10 mm | 1 | 53 | 517.0306 | Double revolving head spanner, 18 x 19 mm | 1 |
| 38 | 503.4614 | GEARplus reversing combination ratcheting spanner, 14 mm | 1 | 46 | 503.4297 | GEARplus socket adaptor, 3/8" x 13 mm | 1 | | | | |

811.0019

M Pliers and file set



| Pos. | Code | Description | pcs |
|------|----------|---|-----|
| 1 | 157.0405 | Tri-bastard file, form C, cut 2, 200 mm | 1 |
| 2 | 157.0105 | Halfround file, form E, cut 2, 20 mm | 1 |
| 3 | 157.0005 | Flat file, form B, cut 2, 200 mm | 1 |
| 4 | 157.0205 | Round file, form F, cut 2, 200 mm | 1 |
| 5 | 907.2166 | Snap off blades 0,5 x1 8 x 100 mm, dispenser with 10 pieces | 10 |
| 6 | 300.0114 | Tape measure with locking device and belt clip, black red, 5 m, 19 mm | 1 |
| 7 | 300.0510 | Pocket vernier calliper 0-150 mm, 235 mm | 1 |
| 8 | 300.0600 | Feeler gauge, 20 Blades, 0,05-1 mm | 1 |
| 9 | 907.2135 | Universal snap off blade knife 18 mm | 1 |
| 10 | 115.1033 | Self grip wrench, 220 mm | 1 |
| 11 | 115.2010 | Water pump pliers, 240 mm | 1 |
| 12 | 500.1026 | Circlip pliers for external circlips, angled, 160 mm | 1 |
| 13 | 500.1029 | Circlip pliers for external circlips, 160 mm | 1 |
| 14 | 500.1032 | Circlip pliers for internal circlips, angled, 160 mm | 1 |
| 15 | 500.1035 | Circlip pliers for internal circlips, 160 mm | 1 |
| 16 | 115.1012 | ERGOTORQUE diagonal side cutter, 160 mm | 1 |
| 17 | 115.1021 | ERGOTORQUE combination pliers, 180 mm | 1 |
| 18 | 115.1019 | ERGOTORQUE bent nose pliers serrated, 210 mm | 1 |
| 19 | 115.1024 | ERGOTORQUE long nose pliers serrated cutter, 200 mm | 1 |

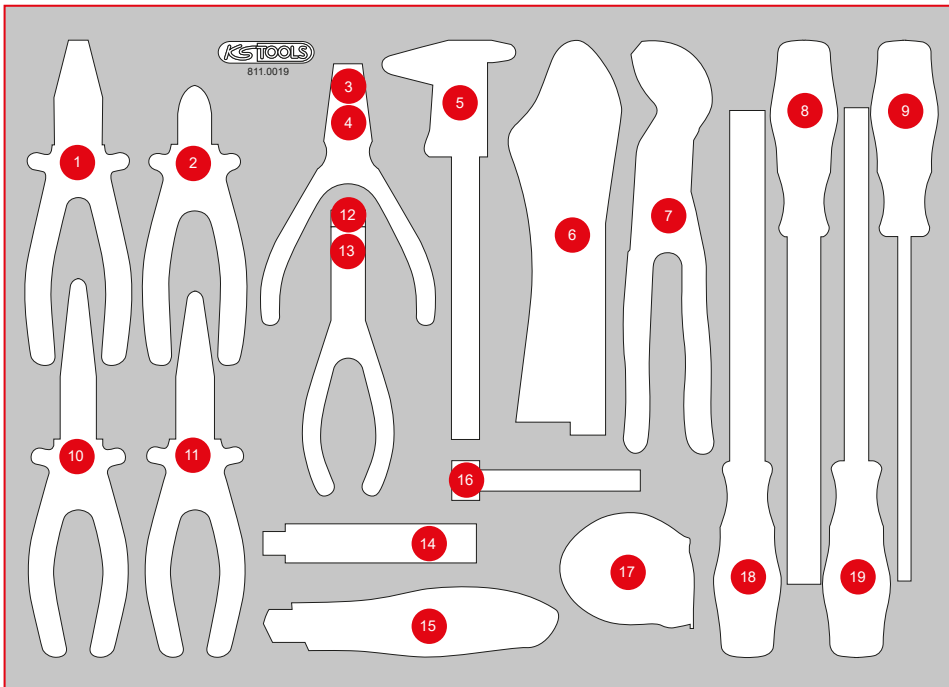

811.0022

M Hammer and chisel set



| Pos. | Code | Description | pcs |
|------|----------|---|-----|
| 1 | 911.8138 | Trim plastic wedge, 195 x 30 mm | 1 |
| 2 | 140.5252 | Recoil free soft faced Hammer, 400 g | 1 |
| 3 | 142.1402 | Fitters Hammer, fiberglas handle, 400 g | 1 |
| 4 | 142.5101 | Club Hammer, fiberglas handle, 1000 g | 1 |
| 5 | 550.1025 | Flexible magnet lifter, 510 mm, Øhead=15 mm | 1 |
| 6 | 550.1001 | 2in1 Telescopic solenoid holder with washer jet cleaning and setting tool, 150 - 675 mm | 1 |
| 7 | 150.4370 | perfectLight torch 85 lumen | 1 |
| 8 | 911.8146 | Tyre lever, 370 mm | 1 |
| 9 | 201.2335 | Steel wire brake saddle brush, 2-row, straight 225 mm | 1 |
| 10 | 156.0241 | Flat chisel, octagon, 20 mm | 1 |
| 11 | 156.0254 | Flat chisel, octagon, 18 mm | 1 |
| 12 | 156.0242 | Cross chisel, octagon, 7 mm | 1 |
| 13 | 156.0243 | Centre punch, octagon 10 mm | 1 |
| 14 | 156.0244 | Punch, Ø 5 mm, conical | 1 |
| 15 | 156.0238 | Punch, Ø 4 mm, conical | 1 |
| 16 | 156.0237 | Punch, Ø 3 mm, conical | 1 |
| 17 | 156.0231 | Pin punch, Ø 3 mm, cylindrical shaft | 1 |
| 18 | 156.0232 | Pin punch, Ø 4 mm, cylindrical shaft | 1 |
| 19 | 156.0233 | Pin punch, Ø 5 mm, cylindrical shaft | 1 |
| 20 | 156.0234 | Pin punch, Ø 6 mm, cylindrical shaft | 1 |
| 21 | 156.0235 | Pin punch, Ø 8 mm, cylindrical shaft | 1 |
| 22 | 907.2232 | Gasket scraper, 25 x 200 mm | 1 |

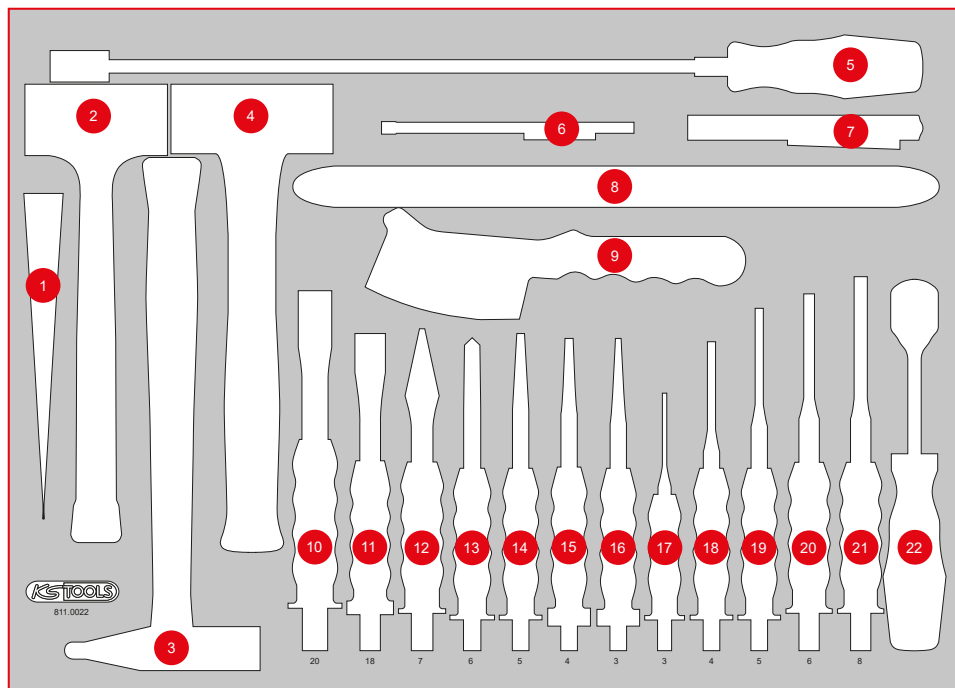

P15

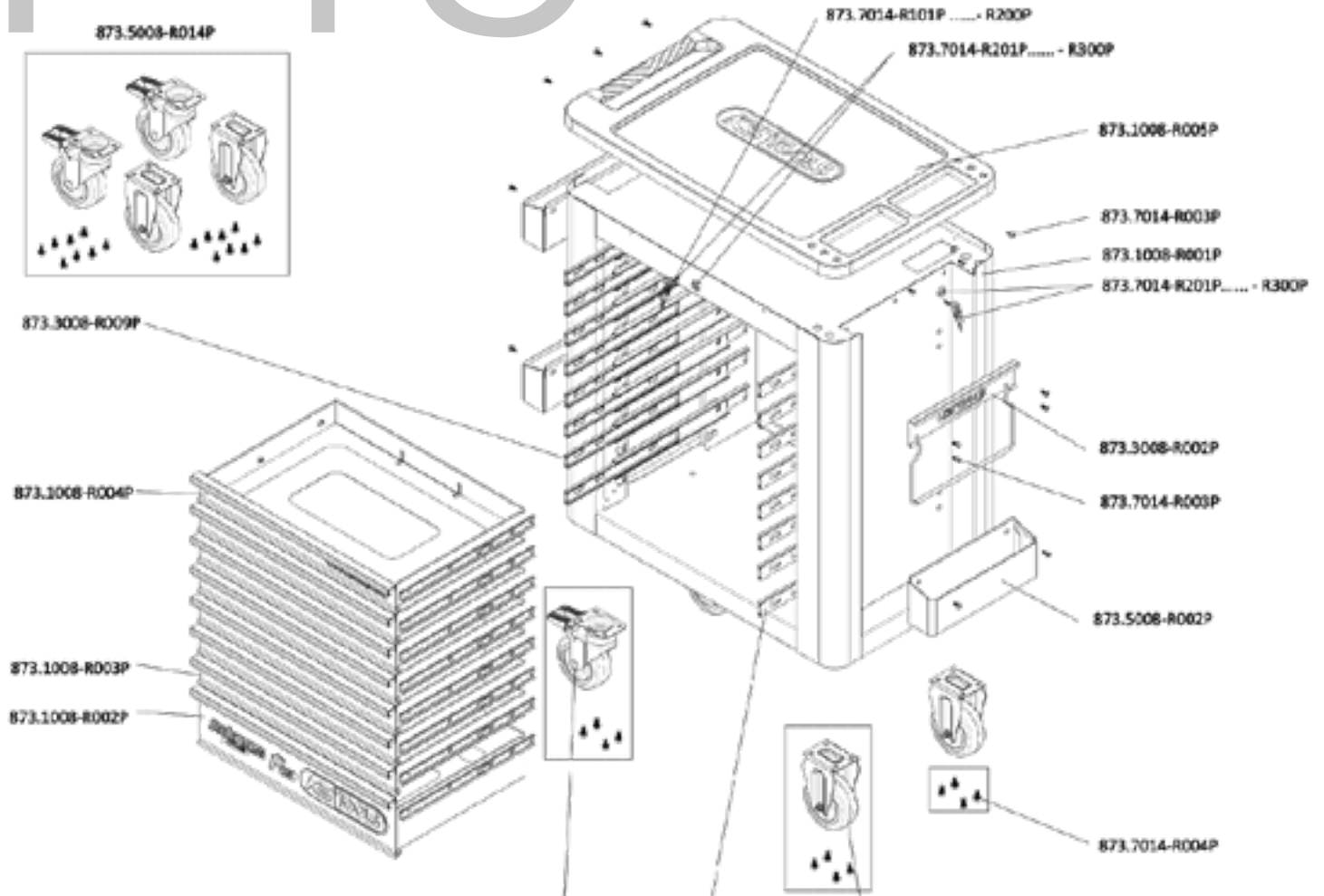

INDIVIDUAL PARTS LIST

| Art.-Nr. | Description | amount |
|-------------------|--|--------|
| 873.7014-R101P... | Replacement key for PERFORMANCEplus workshop trolley lock number xyz | 2 |
| 873.7014-R201P... | Lock with 2 keys for PERFORMANCEplus workshop trolley lock number xyz | 2 |
| 873.1008-R001P | Body of workshop trolley | 1 |
| 873.1008-R002P | Compartment with logo and ball-bearing guide, 568x398x145 mm | 1 |
| 873.1008-R003P | Compartment with ball-bearing guide, for workshop trolley P10/P10TC/P15, 568x398x65 mm | 6 |
| 873.1008-R004P | Compartment with website and ball-bearing guide, for workshop trolley P10/P15, 568x398x65 mm | 1 |
| 873.1008-R005P | Plastic work surface with handle | 1 |
| 873.3008-R002P | Paper roll holder for PERFORMANCEplus workshop trolley P10/P15/P25 | 1 |
| 873.3008-R008P | Full extension (with ball-bearing guide) with automatic retraction | 8 |
| 873.3008-R009P | Full extension (with ball-bearing guide) with automatic retraction | 8 |
| 873.5008-R002P | Can holder for PERFORMANCEplus workshop trolley P10/P15/P25/P35 | 3 |
| 873.5008-R009P | Fixed castors for PERFORMANCEplus workshop trolley, incl. screws | 2 |
| 873.5008-R011P | Swivel castors with brakes, for PERFORMANCEplus workshop trolley, incl. screws | 2 |
| 873.5008-R014P | Roller set for PERFORMANCEplus workshop trolley, incl. screws | 1 |
| 873.7014-R003P | M6x12 screw (1 pcs.) for PERFORMANCEplus workshop trolley accessories | 16 |
| 873.7014-R004P | M8 screws for PERFORMANCEplus workshop trolley rollers (16 pcs.) | 1 |



873.7014-R101P...R200P
Replacement key for lock number xyz



873.7014-R201P...R300P
Lock with 2 keys, lock number xyz



873.3008-R008P
Full extension (with ball-bearing guide) with automatic retraction, right



873.3008-R009P
Full extension (with ball-bearing guide) with automatic retraction, left



873.5008-R009P
Fixed castors, incl. screws



873.5008-R011P
Swivel castors with brakes, incl. screws



873.5008-R014P
Roller set, incl. screws



873.1008-R005P
Plastic work surface with handle



873.1008-R004P
Compartment with website and ball-bearing guide, 568x398x65 mm



873.1008-R003P
Compartment with ball-bearing guide, 568x398x65 mm



873.1008-R002P
Compartment with logo and ball-bearing guide, 568x398x145 mm



873.5008-R002P
Can holder including screws, W = 310 mm



873.3008-R002P
Paper roll holder including screws, W= 320 mm



873.7014-R004P
M8 screws (16 pcs.)



873.7014-R003P
M6x12 screw (1 pcs.)



873.1008-R001P
Body of workshop trolley



The only thing that
can't be replaced is
the quality!